

Single channel high side driver for automotive applications

Features

Max supply voltage	V_{CC}	41V
Operating voltage range	V_{CC}	4.5 to 36V
Max on-state resistance (per ch.)	R_{ON}	160 m Ω
Current limitation (typ)	I_{LIMH}	5.4 A
Off-state supply current	I_S	2 μ A ⁽¹⁾

1. Typical value with all loads connected

- Main
 - Inrush current active management by power limitation
 - Very low stand-by current
 - 3.0V CMOS compatible input
 - Optimized electromagnetic emission
 - Very low electromagnetic susceptibility
 - In compliance with the 2002/95/EC european directive
- Diagnostic Functions
 - Open drain status output
 - On-state open load detection
 - Off-state open load detection
 - Thermal shutdown indication
- Protection
 - Undervoltage shutdown
 - Overvoltage clamp
 - Output stuck to Vcc detection
 - Load current limitation
 - Self limiting of fast thermal transients
 - Protection against loss of ground and loss of V_{CC}
 - Thermal shutdown

Table 1. Device summary

Package	Order codes	
	Tube	Tape and reel
SO-8	VN5160S-E	VN5160STR-E

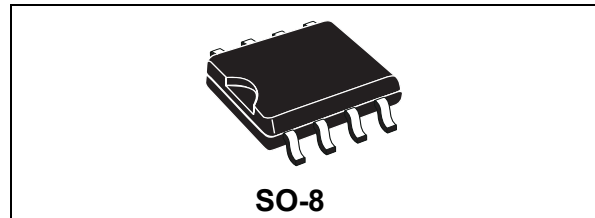

- Reverse battery protection (see [Figure 28](#))
- Electrostatic discharge protection

Applications

- All types of resistive, inductive and capacitive loads

Description

The VN5160S-E is a monolithic device made using STMicroelectronics VIPower M0-5 technology. It is intended for driving resistive or inductive loads with one side connected to ground. Active V_{CC} voltage clamp protects the device against low energy spikes. The device detects open load condition both in on and off-state, when STAT_DIS is left open or driven low. Output shorted to V_{CC} is detected in the off-state. When STAT_DIS is driven high, STATUS is in a high impedance condition. Output current limitation protects the device in overload condition. In case of long duration overload, the device limits the dissipated power to safe level up to thermal shutdown intervention. Thermal shutdown with automatic restart allows the device to recover normal operation as soon as fault condition disappears.

Contents

1	Block diagram and pins description	5
2	Electrical specifications	7
2.1	Absolute maximum ratings	7
2.2	Thermal data	8
2.3	Electrical characteristics	9
2.4	Electrical characteristics curves	16
3	Application Information	20
3.1	GND protection network against reverse battery	20
3.1.1	Solution 1: resistor in the ground line (RGND only)	20
3.1.2	Solution 2: a diode (DGND) in the ground line	21
3.2	Load dump protection	21
3.3	MCU I/Os protection	21
3.4	Open load detection in off-state	21
3.5	Maximum demagnetization energy (VCC = 13.5V)	23
4	Package and PCB thermal data	24
4.1	SO-8 thermal data	24
5	Package and packing information	27
5.1	ECOPACK [®] packages	27
5.2	Package mechanical data	27
5.3	Packing information	29
6	Revision history	30

List of tables

Table 1.	Device summary	1
Table 2.	Pins function	5
Table 3.	Suggested connections for unused and N.C. pins	6
Table 4.	Absolute maximum ratings	7
Table 5.	Thermal data	8
Table 6.	Power section	9
Table 7.	Switching ($V_{CC} = 13V$; $T_j = 25^{\circ}C$)	9
Table 8.	Status pin ($V_{SD}=0$)	10
Table 9.	Protection	10
Table 10.	Openload detection	11
Table 11.	Logic input	11
Table 12.	Truth table	13
Table 13.	Electrical transient requirements (part 1/3)	14
Table 14.	Electrical transient requirements (part 2/3)	14
Table 15.	Electrical transient requirements (part 3/3)	14
Table 16.	Thermal parameter	26
Table 17.	SO-8 mechanical data	28
Table 18.	Document revision history	30

List of figures

Figure 1.	Block diagram	5
Figure 2.	Configuration diagram (top view)	6
Figure 3.	Current and voltage conventions	7
Figure 4.	Status timings	12
Figure 5.	Output voltage drop limitation	12
Figure 6.	Switching characteristics	13
Figure 7.	Waveforms	15
Figure 8.	Off-state output current	16
Figure 9.	Input clamp voltage	16
Figure 10.	High-level input current	16
Figure 11.	Input high-level voltage	16
Figure 12.	Input low-level voltage	16
Figure 13.	Input hysteresis voltage	16
Figure 14.	Status low-output voltage	17
Figure 15.	Status leakage current	17
Figure 16.	Status clamp voltage	17
Figure 17.	On-state resistance vs T_{case}	17
Figure 18.	On-state resistance vs V_{CC}	17
Figure 19.	Open-load on-state detection threshold	17
Figure 20.	Open-load off-state voltage detection threshold	18
Figure 21.	Turn-on voltage slope	18
Figure 22.	Turn-off voltage slope	18
Figure 23.	I_{LIM} vs T_{case}	18
Figure 24.	Undervoltage shutdown	18
Figure 25.	STAT_DIS clamp voltage	18
Figure 26.	High-level STAT_DIS voltage	19
Figure 27.	Low-level STAT_DIS voltage	19
Figure 28.	Application schematic	20
Figure 29.	Open-load detection in off-state	22
Figure 30.	Maximum turn-off current versus inductance	23
Figure 31.	SO-8 PC board	24
Figure 32.	$R_{thj-amb}$ vs PCB copper area in open box free air condition	24
Figure 33.	SO-8 Thermal impedance junction ambient single pulse	25
Figure 34.	Thermal fitting model of a single-channel HSD in SO-8 ⁽¹⁾	25
Figure 35.	SO-8 package dimensions	27
Figure 36.	SO-8 tube shipment (no suffix)	29
Figure 37.	SO-8 tape and reel shipment (suffix "TR")	29

1 Block diagram and pins description

Figure 1. Block diagram

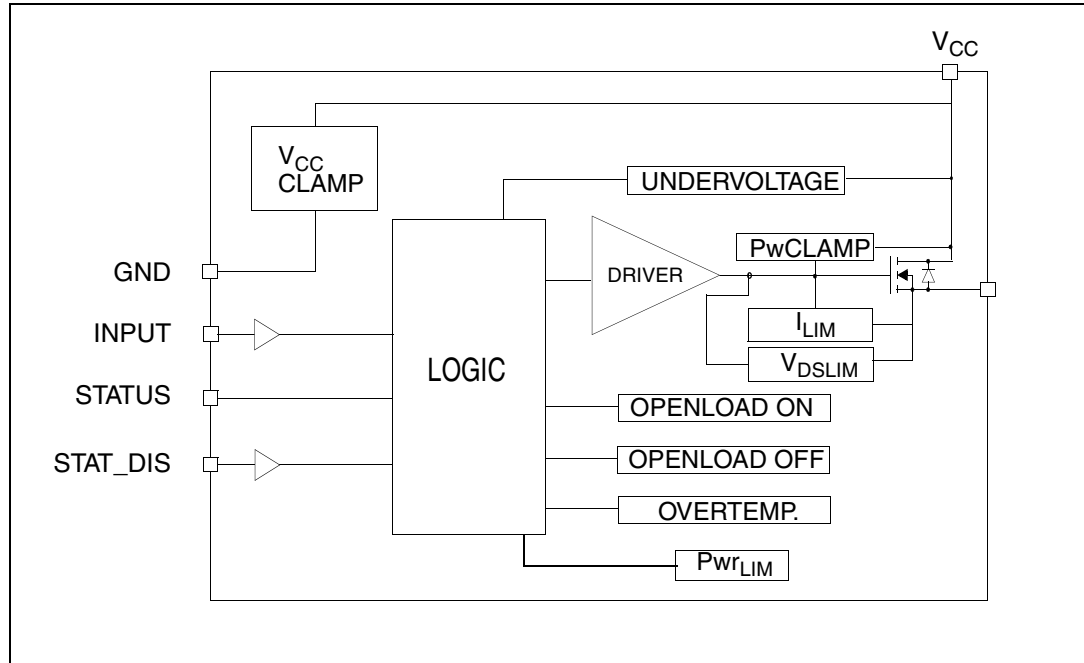

Table 2. Pins function

Name	Function
V _{CC}	Battery connection.
OUTPUT	Power output.
GND	Ground connection. Must be reverse battery protected by an external diode/resistor network.
INPUT	Voltage controlled input pin with hysteresis, CMOS compatible. Controls output switch state.
STATUS	Open drain digital diagnostic pin.
STAT_DIS	Active high CMOS compatible pin, to disable the STATUS pin.

Figure 2. Configuration diagram (top view)

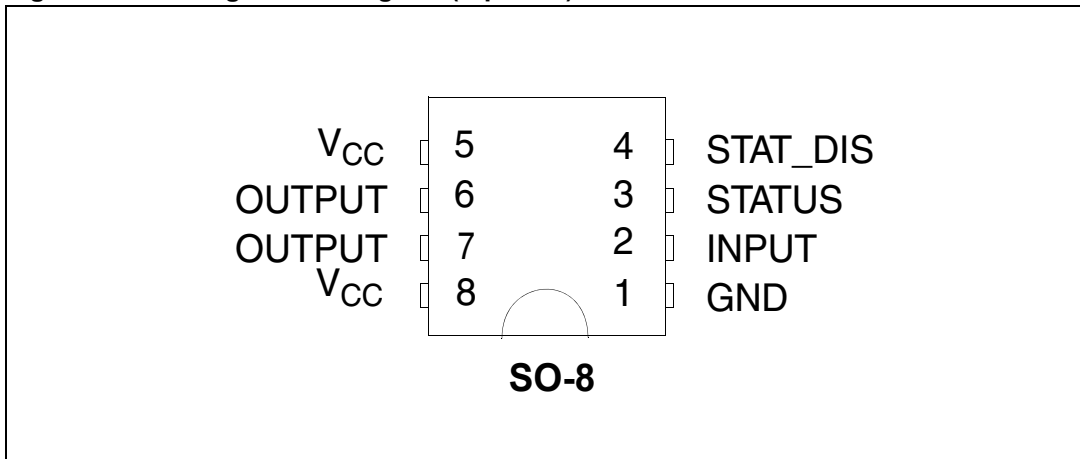

Table 3. Suggested connections for unused and N.C. pins

Connection / Pin	Status	N.C.	Output	Input	STAT_DIS
Floating	X	X	X	X	X
To ground	N.R. ⁽¹⁾	X	N.R.	Through 10KΩ resistor	Through 10KΩ resistor

1. Not recommended.

2 Electrical specifications

Figure 3. Current and voltage conventions

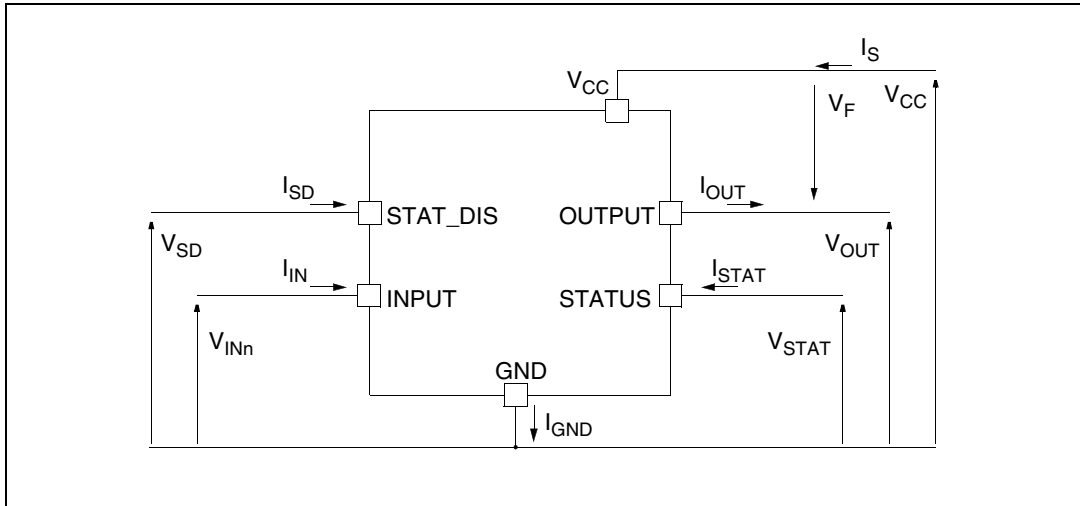

Note: $V_F = V_{OUT} - V_{CC}$ during reverse battery condition.

2.1 Absolute maximum ratings

Stressing the device above the ratings listed in the “Absolute maximum ratings” tables may cause permanent damage to the device. These are stress ratings only and operation of the device at these or any other conditions above those indicated in the Operating sections of this specification is not implied. Exposure to the conditions in this section for extended periods may affect device reliability. Refer also to the STMicroelectronics SURE Program and other relevant quality documents.

Table 4. Absolute maximum ratings

Symbol	Parameter	Value	Unit
V_{CC}	DC supply voltage	41	V
$-V_{CC}$	Reverse DC supply voltage	0.3	V
$-I_{GND}$	DC reverse ground pin current	200	mA
I_{OUT}	DC output current	Internally limited	A
$-I_{OUT}$	Reverse DC output current	6	A
I_{IN}	DC input current	+10 / -1	mA
I_{STAT}	DC status current	+10 / -1	mA
I_{STAT_DIS}	DC status disable current	+10 / -1	mA
E_{MAX}	Maximum switching energy (single pulse) ($L = 12\text{mH}$; $R_L = 0\Omega$; $V_{bat} = 13.5\text{V}$; $T_{jstart} = 150^\circ\text{C}$; $I_{OUT} = I_{limL}(\text{Typ.})$)	34	mJ

Table 4. Absolute maximum ratings (continued)

Symbol	Parameter	Value	Unit
V_{ESD}	Electrostatic discharge (Human Body Model: R=1.5K Ω ; C=100pF)		
	– INPUT	4000	V
	– STATUS	4000	V
	– STAT_DIS	4000	V
	– OUTPUT	5000	V
	– V _{CC}	5000	V
V_{ESD}	Charge device model (CDM-AEC-Q100-011)	750	V
T_j	Junction operating temperature	-40 to 150	°C
T_{stg}	Storage temperature	-55 to 150	°C

2.2 Thermal data

Table 5. Thermal data

Symbol	Parameter	Value	Unit
$R_{thj-pins}$	Thermal resistance junction-pins (MAX)	30	°C/W
$R_{thj-amb}$	Thermal resistance junction-ambient (MAX)	See Figure 32	°C/W

2.3 Electrical characteristics

Values specified in this section are for $8V < V_{CC} < 36V$; $-40^{\circ}C < T_j < 150^{\circ}C$, unless otherwise stated.

Table 6. Power section

Symbol	Parameter	Test conditions	Min.	Typ.	Max.	Unit
V_{CC}	Operating supply voltage		4.5	13	36	V
V_{USD}	Undervoltage shutdown			3.5	4.5	V
$V_{USDhyst}$	Undervoltage shutdown hysteresis			0.5		V
$R_{ON}^{(1)}$	On-state resistance	$I_{OUT}=1A$; $T_j=25^{\circ}C$			160	m Ω
		$I_{OUT}=1A$; $T_j=150^{\circ}C$			320	m Ω
		$I_{OUT}=1A$; $V_{CC}=5V$; $T_j=25^{\circ}C$			210	m Ω
V_{clamp}	Clamp voltage	$I_S = 20mA$	41	46	52	V
I_S	Supply current	Off-state; $V_{CC}=13V$; $V_{IN}=V_{OUT}=0V$; $T_j=25^{\circ}C$;		2 ⁽²⁾	5 ⁽¹⁾⁽²⁾	μA
		On-state; $V_{CC}=13V$; $V_{IN}=5V$; $I_{OUT}=0A$		1.9	3.5	mA
$I_{L(off1)}$	Off-state output current ⁽²⁾	$V_{IN}=V_{OUT}=0V$; $V_{CC}=13V$; $T_j=25^{\circ}C$	0	0.01	3	μA
		$V_{IN}=V_{OUT}=0V$; $V_{CC}=13V$; $T_j=125^{\circ}C$	0		5	
$I_{L(off2)}$		$V_{IN}=0V$; $V_{OUT}=4V$	-75		0	
V_F	Output - V_{CC} diode voltage	$-I_{OUT}=0.6A$; $T_j=150^{\circ}C$			0.7	V

1. Guaranteed by design/characterization

2. PowerMOS leakage included

Table 7. Switching ($V_{CC} = 13V$; $T_j = 25^{\circ}C$)

Symbol	Parameter	Test conditions	Min.	Typ.	Max.	Unit
$t_{d(on)}$	Turn-on delay time	$R_L = 13\Omega$ (see Figure 6)		10		μs
$t_{d(off)}$	Turn-off delay time	$R_L = 13\Omega$ (see Figure 6)		15		μs
$dV_{OUT}/dt_{(on)}$	Turn-on voltage slope	$R_L = 13\Omega$	See Figure 21			V/ μs
$dV_{OUT}/dt_{(off)}$	Turn-off voltage slope	$R_L = 13\Omega$	See Figure 22			V/ μs
W_{ON}	Switching energy losses during t_{won}	$R_L = 13\Omega$ (see Figure 6)		0.04		mJ
W_{OFF}	Switching energy losses during t_{woff}	$R_L = 13\Omega$ (see Figure 6)		0.04		mJ

Table 8. Status pin ($V_{SD}=0$)

Symbol	Parameter	Test conditions	Min.	Typ.	Max.	Unit
V_{STAT}	Status low output voltage	$I_{STAT}= 1.6 \text{ mA}$, $V_{SD}= 0\text{V}$			0.5	V
I_{LSTAT}	Status leakage current	Normal operation or $V_{SD}= 5\text{V}$, $V_{STAT}= 5\text{V}$			10	μA
C_{STAT}	Status pin input capacitance	Normal operation or $V_{SD}=5\text{V}$, $V_{STAT}= 5\text{V}$			100	pF
V_{SCL}	Status clamp voltage	$I_{STAT}= 1\text{mA}$ $I_{STAT}= - 1\text{mA}$	5.5	-0.7	7	V V

Table 9. Protection (1)

Symbol	Parameter	Test conditions	Min.	Typ.	Max.	Unit
I_{limH}	DC short circuit current	$V_{CC}= 13\text{V}$ $5\text{V}<V_{CC}<36\text{V}$	3.8	5.4	7.5 7.5	A A
I_{limL}	Short circuit current during thermal cycling	$V_{CC}= 13\text{V}$; $T_R<T_j<T_{TSD}$		2		A
T_{TSD}	Shutdown temperature		150	175	200	$^{\circ}\text{C}$
T_R	Reset temperature		$T_{RS} + 1$	$T_{RS} + 5$		$^{\circ}\text{C}$
T_{RS}	Thermal reset of STATUS		135			$^{\circ}\text{C}$
T_{HYST}	Thermal hysteresis ($T_{TSD}-T_R$)			7		$^{\circ}\text{C}$
t_{SDL}	Status delay in overload conditions	$T_j>T_{TSD}$			20	μs
V_{DEMAG}	Turn-off output voltage clamp	$I_{OUT}=150\text{mA}$; $V_{IN}=0$	$V_{CC}-41$	$V_{CC}-46$	$V_{CC}-52$	V
V_{ON}	Output voltage drop limitation	$I_{OUT}= 0.03\text{A}$; $T_j=-40^{\circ}\text{C}...+150^{\circ}\text{C}$ (see Figure 5)		25		mV

1. To ensure long term reliability under heavy overload or short circuit conditions, protection and related diagnostic signals must be used together with a proper software strategy. If the device is subjected to abnormal conditions, this software must limit the duration and number of activation cycles.

Table 10. Openload detection

Symbol	Parameter	Test conditions	Min.	Typ.	Max.	Unit
I_{OL}	Openload on-state detection threshold	$V_{IN} = 5V, 8V < V_{CC} < 18V$	10	See Figure 19	40	mA
$t_{DOL(on)}$	Openload on-state detection delay	$I_{OUT} = 0A, V_{CC} = 13V$ (see Figure 4)			200	μs
t_{POL}	Delay between INPUT falling edge and STATUS rising edge in openload condition	$I_{OUT} = 0A$ (see Figure 4)	200	500	1000	μs
V_{OL}	Openload off-state voltage detection threshold	$V_{IN} = 0V, 8V < V_{CC} < 16V$	2	See Figure 20	4	V
t_{DSTKON}	Output short circuit to V_{CC} detection delay at turn-off	(see Figure 4)	180		t_{POL}	μs

Table 11. Logic input

Symbol	Parameter	Test conditions	Min.	Typ.	Max.	Unit
V_{IL}	Input low level voltage				0.9	V
I_{IL}	Low level input current	$V_{IN} = 0.9V$	1			μA
V_{IH}	Input high level voltage		2.1			V
I_{IH}	High level input current	$V_{IN} = 2.1V$			10	μA
$V_{I(hyst)}$	Input hysteresis voltage		0.25			V
V_{ICL}	Input clamp voltage	$I_{IN} = 1mA$ $I_{IN} = -1mA$	5.5	-0.7	7	V V
V_{SDL}	STAT_DIS low level voltage				0.9	V
I_{SDL}	Low level STAT_DIS current	$V_{CSD} = 0.9V$	1			μA
V_{SDH}	STAT_DIS high level voltage		2.1			V
I_{SDH}	High level STAT_DIS current	$V_{CSD} = 2.1V$			10	μA
$V_{SD(hyst)}$	STAT_DIS hysteresis voltage		0.25			V
V_{SDCL}	STAT_DIS clamp voltage	$I_{SD} = 1mA$ $I_{SD} = -1mA$	5.5	-0.7	7	V V

Figure 4. Status timings

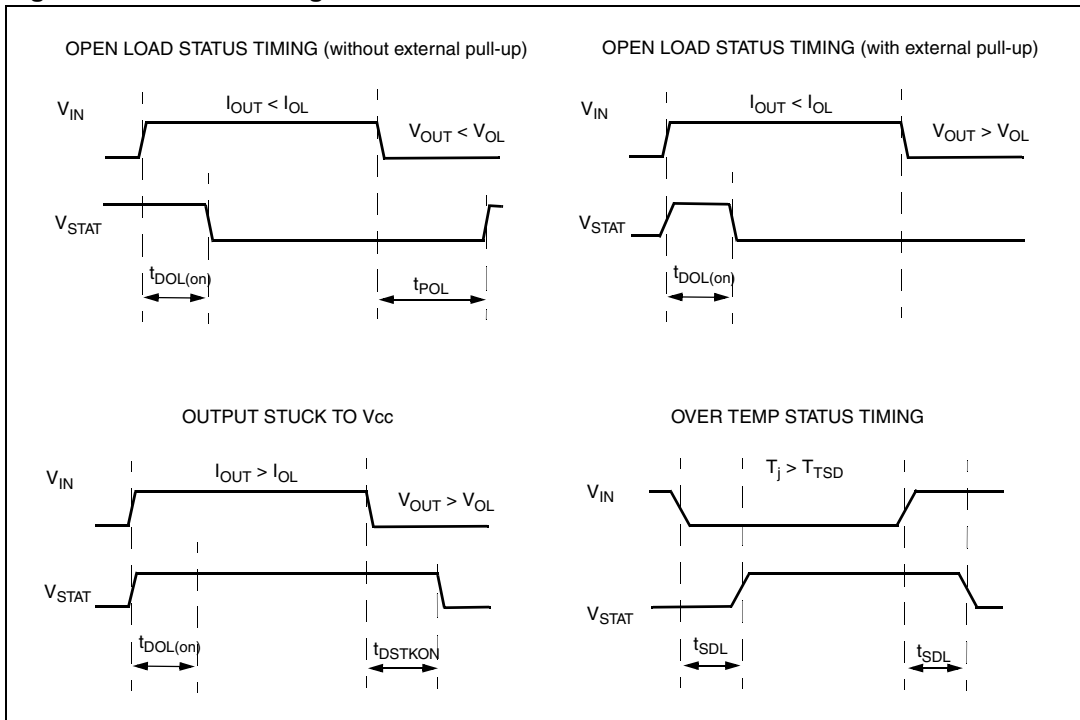

Figure 5. Output voltage drop limitation

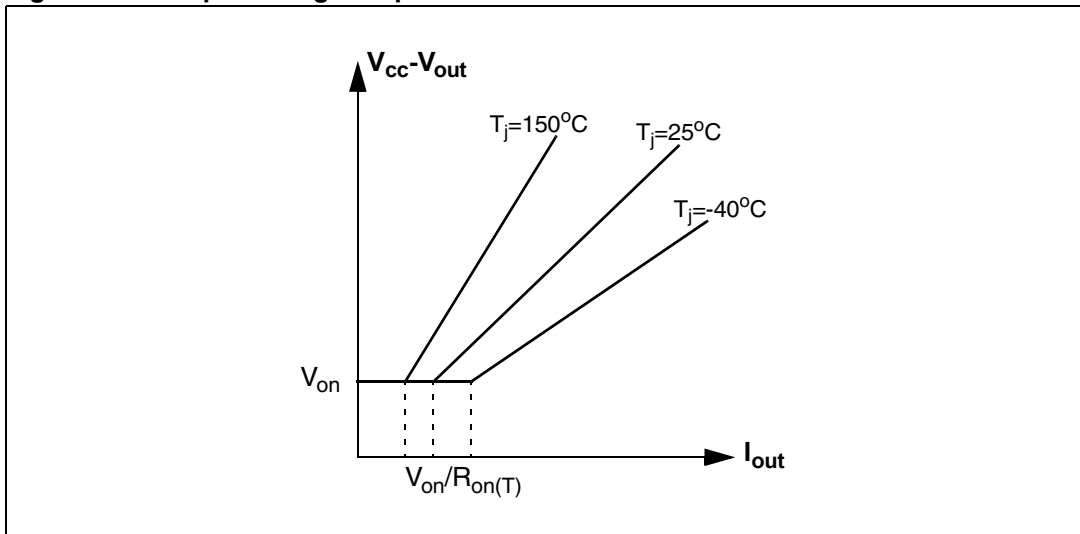

Table 12. Truth table

Conditions	INPUT	OUTPUT	STATUS ($V_{SD}=0V$) ⁽¹⁾
Normal operation	L	L	H
	H	H	H
Current limitation	L	L	H
	H	X	H
Overtemperature	L	L	H
	H	L	L
Undervoltage	L	L	X
	H	L	X
Output voltage > V_{OL}	L	H	L ⁽²⁾
	H	H	H
Output current < I_{OL}	L	L	H ⁽³⁾
	H	H	L

1. If the V_{SD} is high, the STATUS pin is in a high impedance.
2. The STATUS pin is low with a delay equal to t_{DSTKON} after INPUT falling edge.
3. The STATUS pin becomes high with a delay equal to t_{POL} after INPUT falling edge.

Figure 6. Switching characteristics

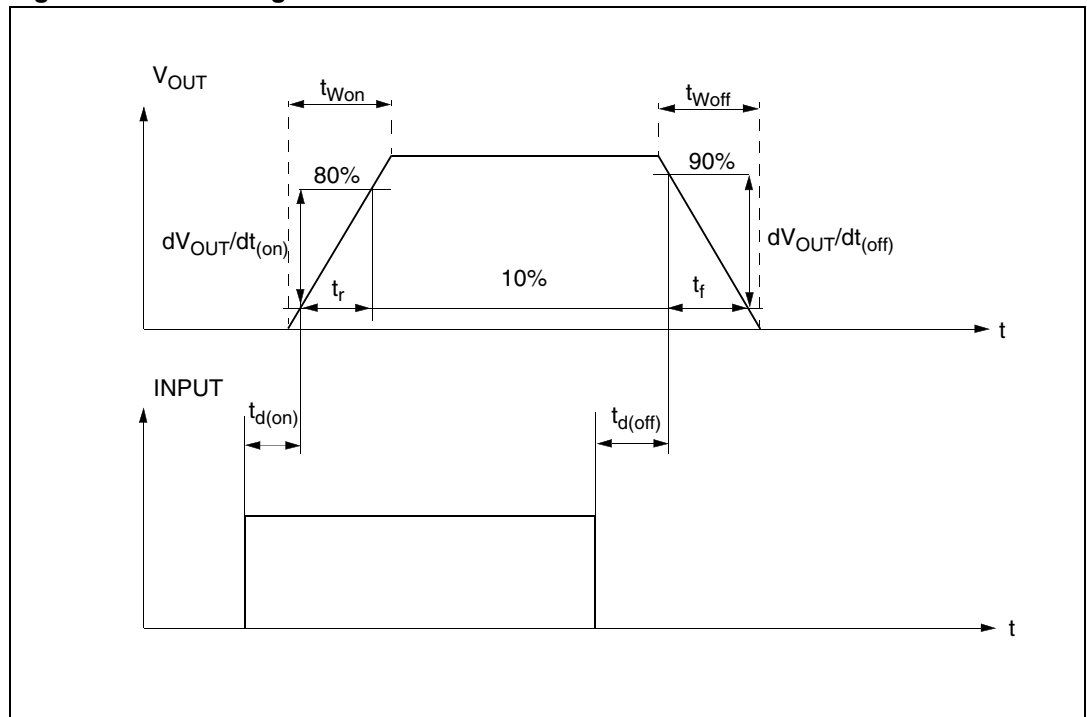

Table 13. Electrical transient requirements (part 1/3)

ISO 7637-2: 2004(E) Test pulse	Test levels		Number of pulses or test times	Burst cycle/pulse repetition time		Delays and impedance
	III	IV				
1	-75V	-100V	5000 pulses	0.5 s	5 s	2 ms, 10 Ω
2a	+37V	+50V	5000 pulses	0.2 s	5 s	50 μs, 2 Ω
3a	-100V	-150V	1h	90 ms	100 ms	0.1 μs, 50 Ω
3b	+75V	+100V	1h	90 ms	100 ms	0.1 μs, 50 Ω
4	-6V	-7V	1 pulse			100 ms, 0.01Ω
5b ⁽¹⁾	+65V	+87V	1 pulse			400 ms, 2 Ω

1. Valid in case of external load dump clamp: 40V maximum referred to ground.

Table 14. Electrical transient requirements (part 2/3)

ISO 7637-2: 2004(E) Test pulse	Test level results ⁽¹⁾	
	III	IV
1	C	C
2a	C	C
3a	C	C
3b	C	C
4	C	C
5b ⁽²⁾	C	C

1. The above test levels must be considered referred to Vcc = 13.5V except for pulse 5b.

2. Valid in case of external load dump clamp: 40V maximum referred to ground.

Table 15. Electrical transient requirements (part 3/3)

Class	Contents
C	All functions of the device are performed as designed after exposure to disturbance.
E	One or more functions of the device are not performed as designed after exposure to disturbance and cannot be returned to proper operation without replacing the device.

Figure 7. Waveforms

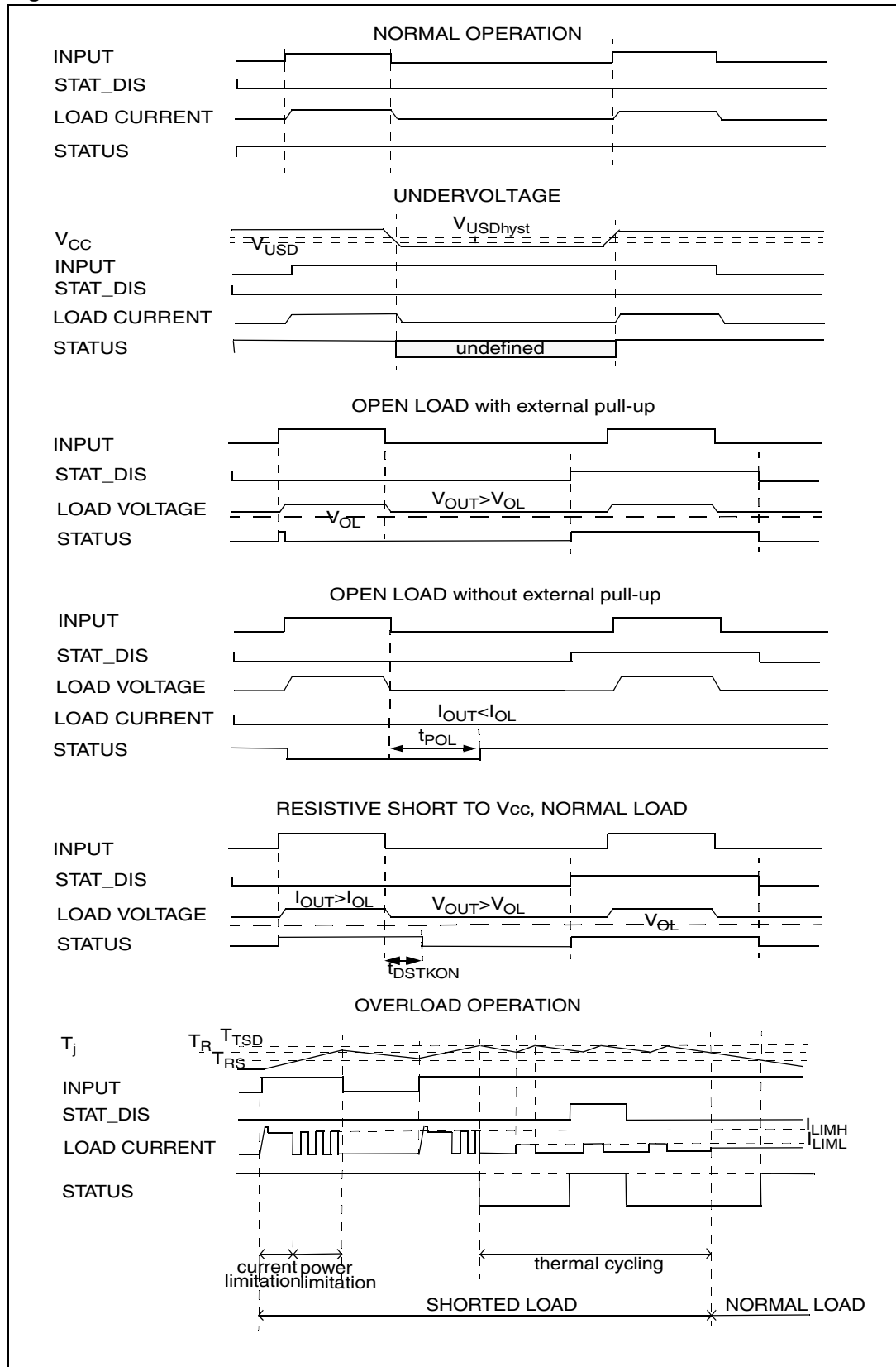

2.4 Electrical characteristics curves

Figure 8. Off-state output current

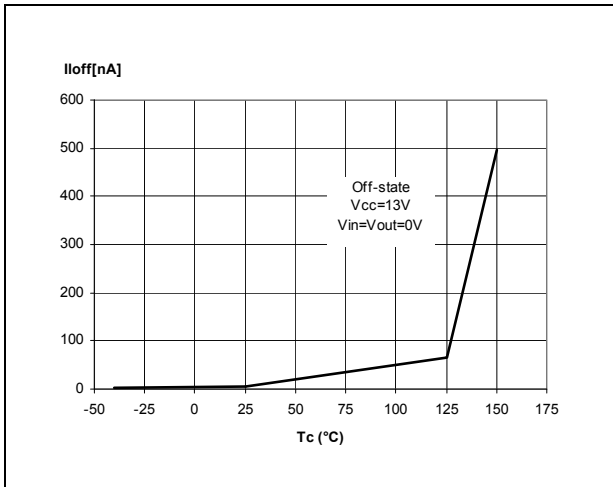

Figure 9. Input clamp voltage

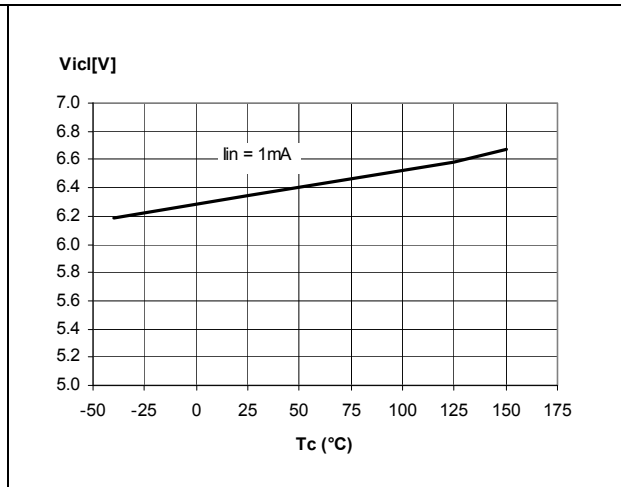

Figure 10. High-level input current

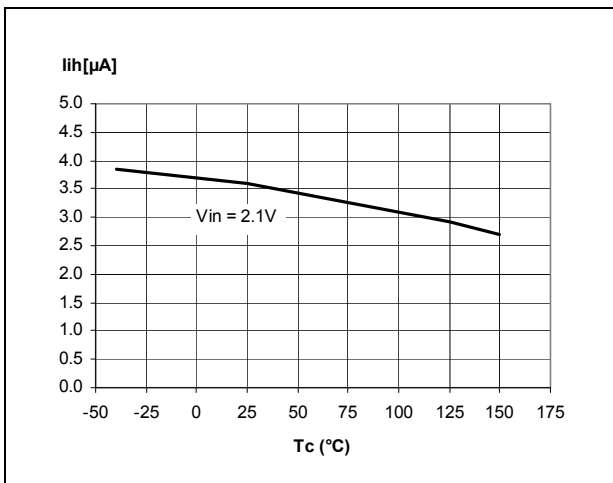

Figure 11. Input high-level voltage

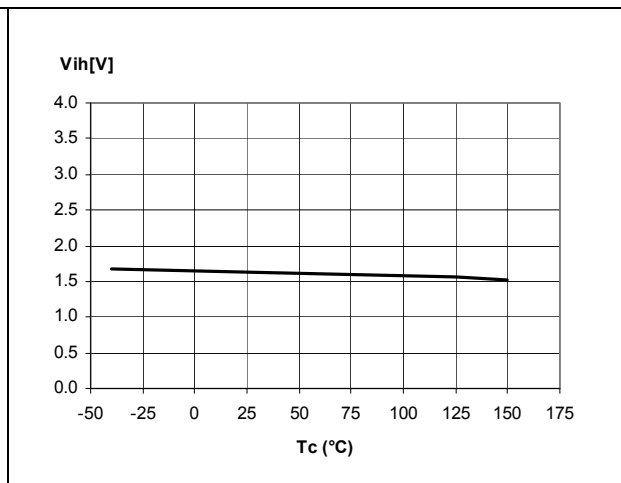

Figure 12. Input low-level voltage

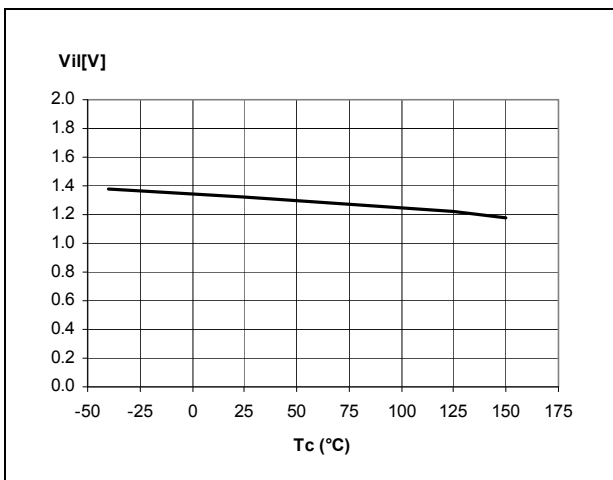

Figure 13. Input hysteresis voltage

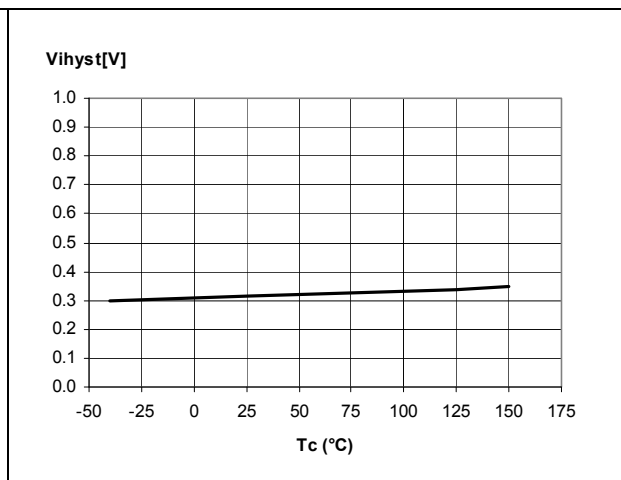

Figure 14. Status low-output voltage

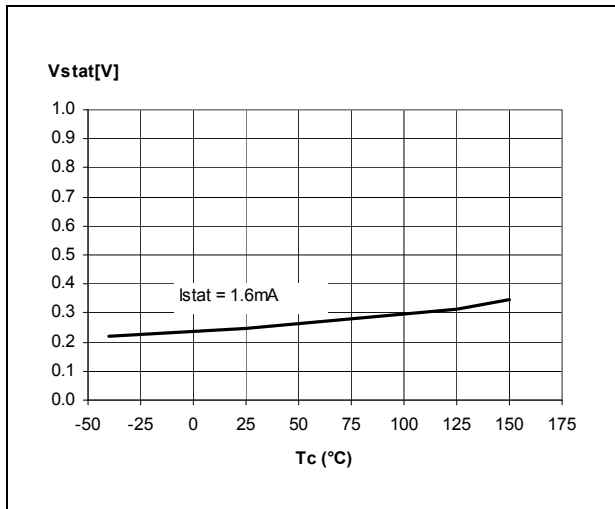

Figure 15. Status leakage current

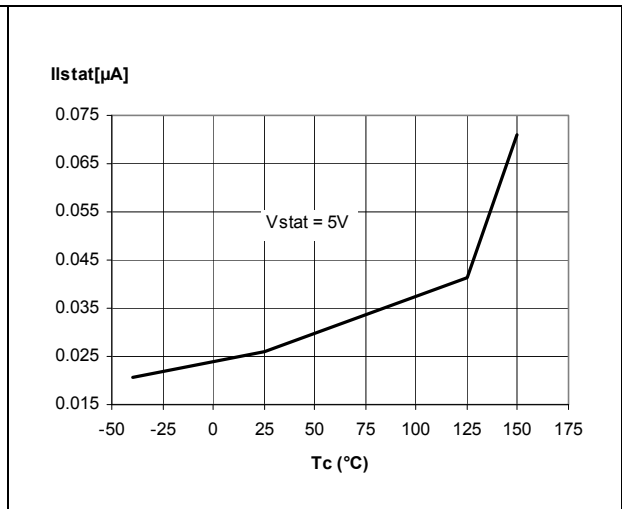

Figure 16. Status clamp voltage

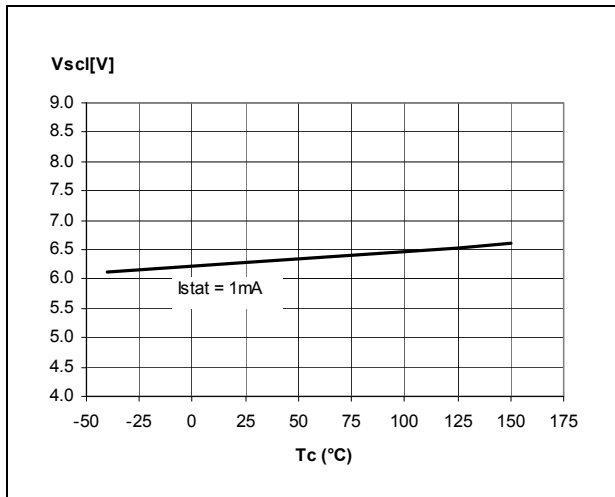

Figure 17. On-state resistance vs T_{case}

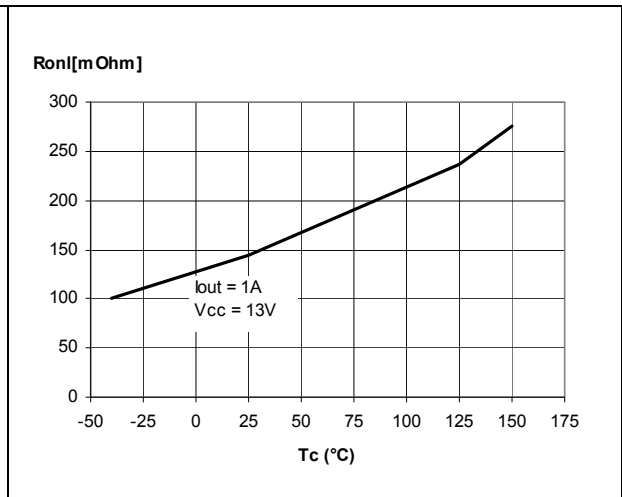

Figure 18. On-state resistance vs V_{CC}

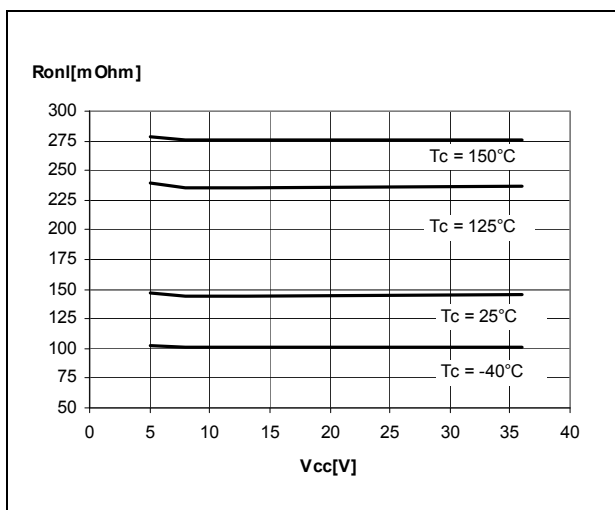

Figure 19. Open-load on-state detection threshold

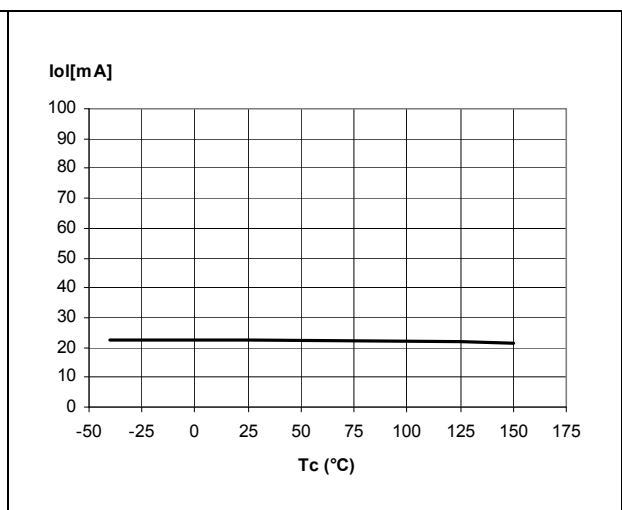

Figure 20. Open-load off-state voltage detection threshold

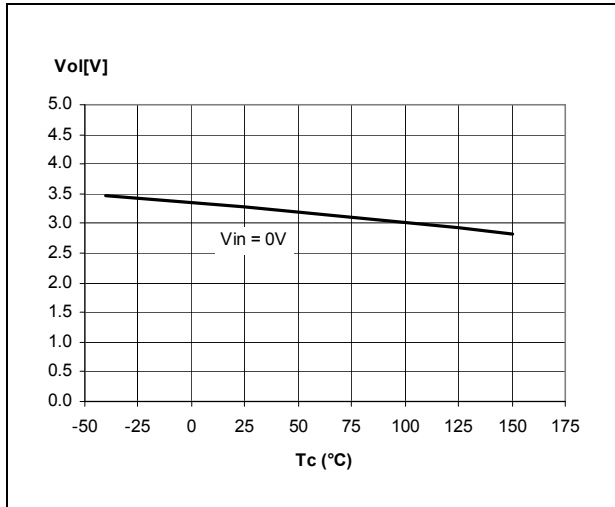

Figure 21. Turn-on voltage slope

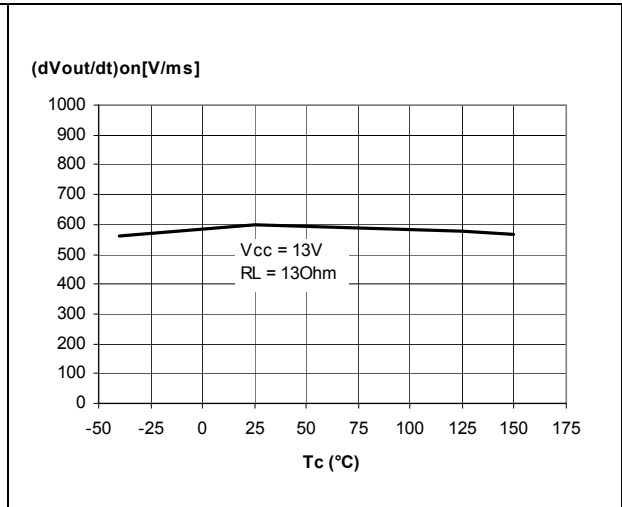

Figure 22. Turn-off voltage slope

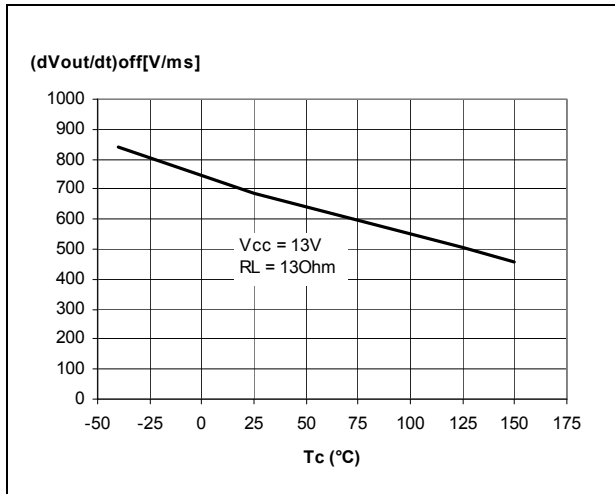

Figure 23. I_{LIM} vs T_{case}

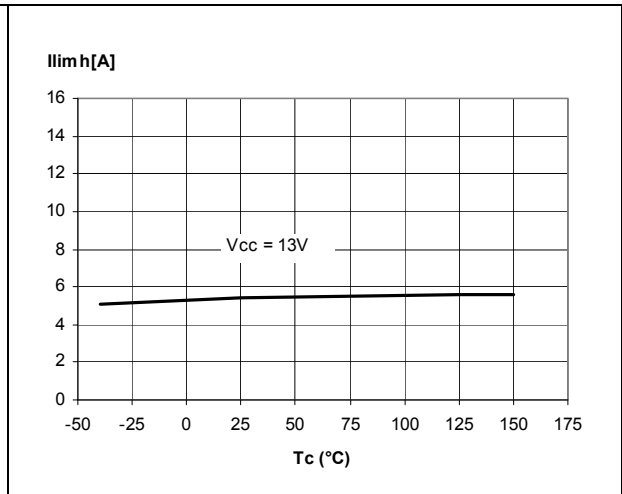

Figure 24. Undervoltage shutdown

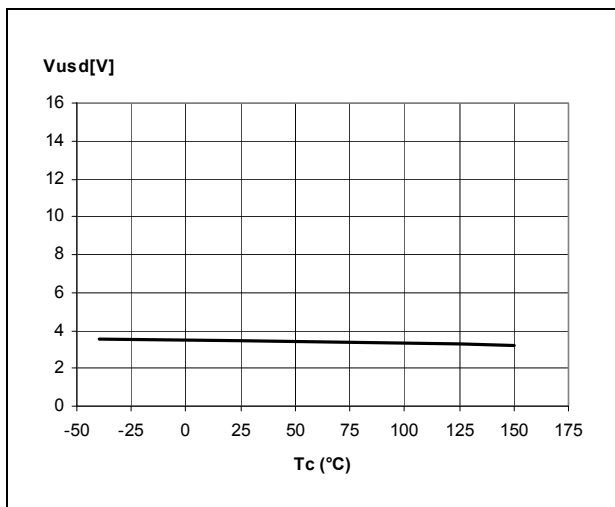

Figure 25. STAT_DIS clamp voltage

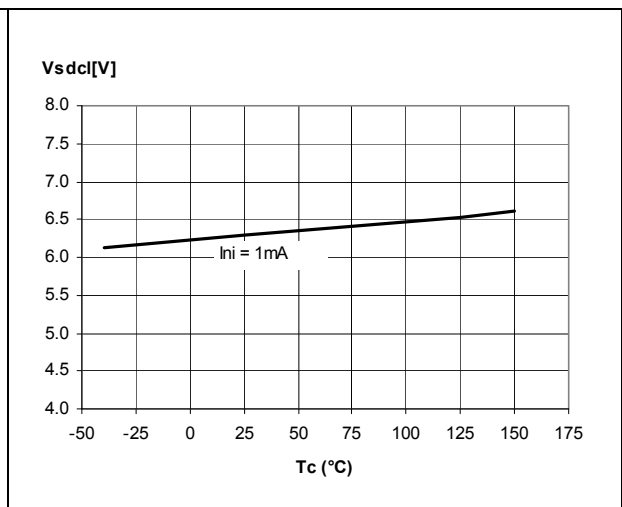

Figure 26. High-level STAT_DIS voltage

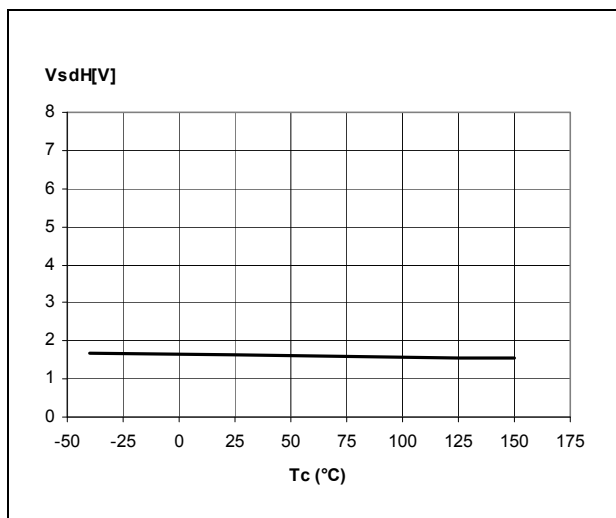
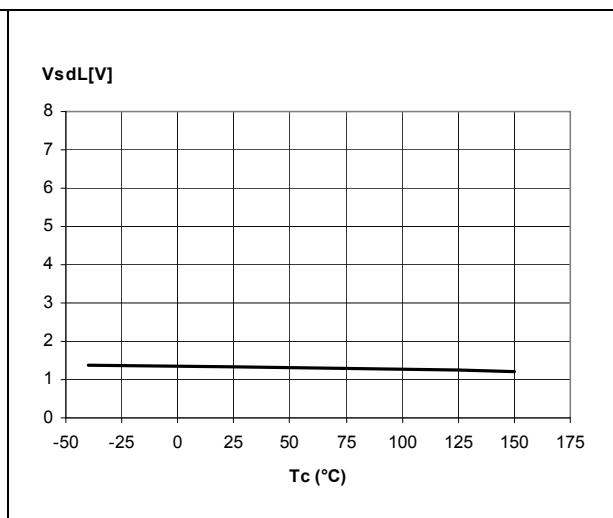
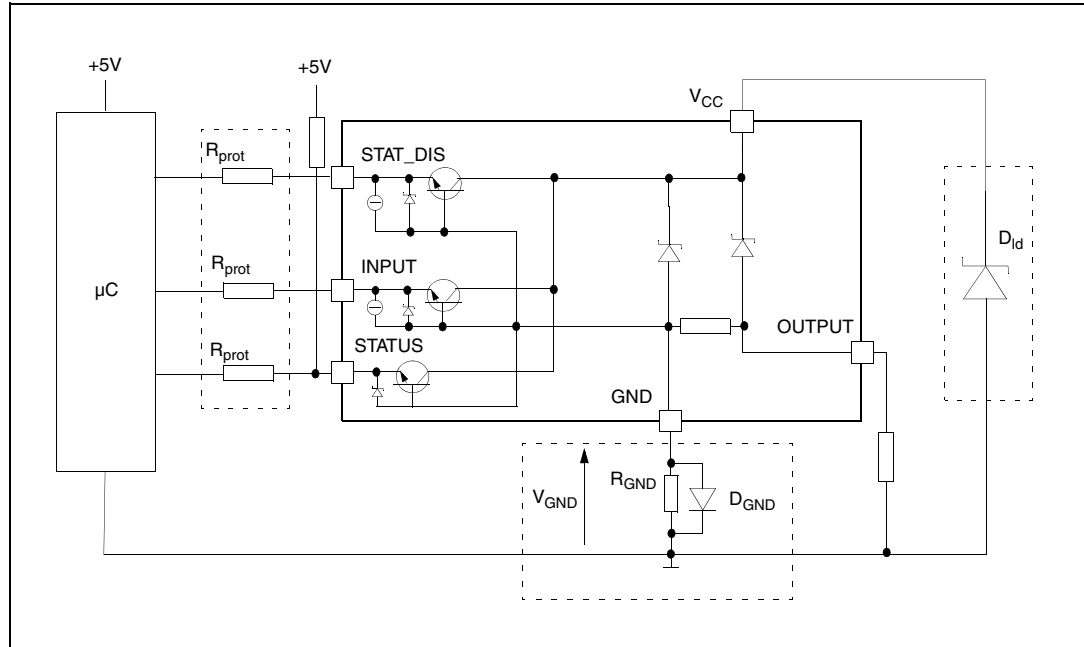

Figure 27. Low-level STAT_DIS voltage



3 Application Information

Figure 28. Application schematic



3.1 GND protection network against reverse battery

3.1.1 Solution 1: resistor in the ground line (R_{GND} only)

This can be used with any type of load.

The following is an indication on how to dimension the R_{GND} resistor.

1. $R_{GND} \leq 600\text{mV} / (I_{S(ON)max})$
2. $R_{GND} \geq (-V_{CC}) / (-I_{GND})$

where -I_{GND} is the DC reverse ground pin current and can be found in the absolute maximum rating section of the device datasheet.

Power dissipation in R_{GND} (when V_{CC}<0: during reverse battery situations) is:

$$P_D = (-V_{CC})^2 / R_{GND}$$

This resistor can be shared amongst several different HSDs. Please note that the value of this resistor should be calculated with formula (1) where I_{S(ON)max} becomes the sum of the maximum On-state currents of the different devices.

Please note that if the microprocessor ground is not shared by the device ground then the R_{GND} will produce a shift (I_{S(ON)max} * R_{GND}) in the input thresholds and the status output values. This shift will vary depending on how many devices are ON in the case of several high side drivers sharing the same R_{GND}.

If the calculated power dissipation leads to a large resistor or several devices have to share the same resistor then ST suggests to utilize Solution 2 (see below).

3.1.2 Solution 2: a diode (D_{GND}) in the ground line

A resistor ($R_{GND}=1k\Omega$) should be inserted in parallel to D_{GND} if the device drives an inductive load.

This small signal diode can be safely shared amongst several different HSDs. Also in this case, the presence of the ground network will produce a shift ($\approx 600mV$) in the input threshold and in the status output values if the microprocessor ground is not common to the device ground. This shift will not vary if more than one HSD shares the same diode/resistor network.

3.2 Load dump protection

D_{ld} is necessary (Voltage Transient Suppressor) if the load dump peak voltage exceeds the V_{CC} max DC rating. The same applies if the device is subject to transients on the V_{CC} line that are greater than the ones shown in the ISO 7637-2: 2004(E) table.

3.3 MCU I/Os protection

If a ground protection network is used and negative transient are present on the V_{CC} line, the control pins will be pulled negative. ST suggests to insert a resistor (R_{prot}) in line to prevent the μC I/Os pins to latch-up.

The value of these resistors is a compromise between the leakage current of μC and the current required by the HSD I/Os (Input levels compatibility) with the latch-up limit of μC I/Os.

$$-V_{CCpeak}/I_{latchup} \leq R_{prot} \leq (V_{OH\mu C} - V_{IH} - V_{GND}) / I_{IHmax}$$

Calculation example:

For $V_{CCpeak} = -100V$ and $I_{latchup} \geq 20mA$; $V_{OH\mu C} \geq 4.5V$

$$5k\Omega \leq R_{prot} \leq 180k\Omega$$

Recommended R_{prot} values is $10k\Omega$.

3.4 Open load detection in off-state

Off-state open load detection requires an external pull-up resistor (R_{PU}) connected between OUTPUT pin and a positive supply voltage (V_{PU}) like the +5V line used to supply the microprocessor.

The external resistor has to be selected according to the following requirements:

- no false open load indication when load is connected: in this case we have to avoid V_{OUT} to be higher than V_{OImin} ; this results in the following condition $V_{OUT} = (V_{PU}/(R_L + R_{PU}))R_L < V_{OImin}$.
- no misdetection when load is disconnected: in this case the V_{out} has to be higher than V_{OLmax} ; this results in the following condition $R_{PU} < (V_{PU} - V_{OLmax})/I_{L(off2)}$.

Because $I_{s(OFF)}$ may significantly increase if V_{out} is pulled high (up to several mA), the pull-up resistor R_{PU} should be connected to a supply that is switched OFF when the module is in standby.

The values of V_{OLmin} , V_{OLmax} and $I_{L(off2)}$ are available in the Electrical characteristics section.

Figure 29. Open-load detection in off-state

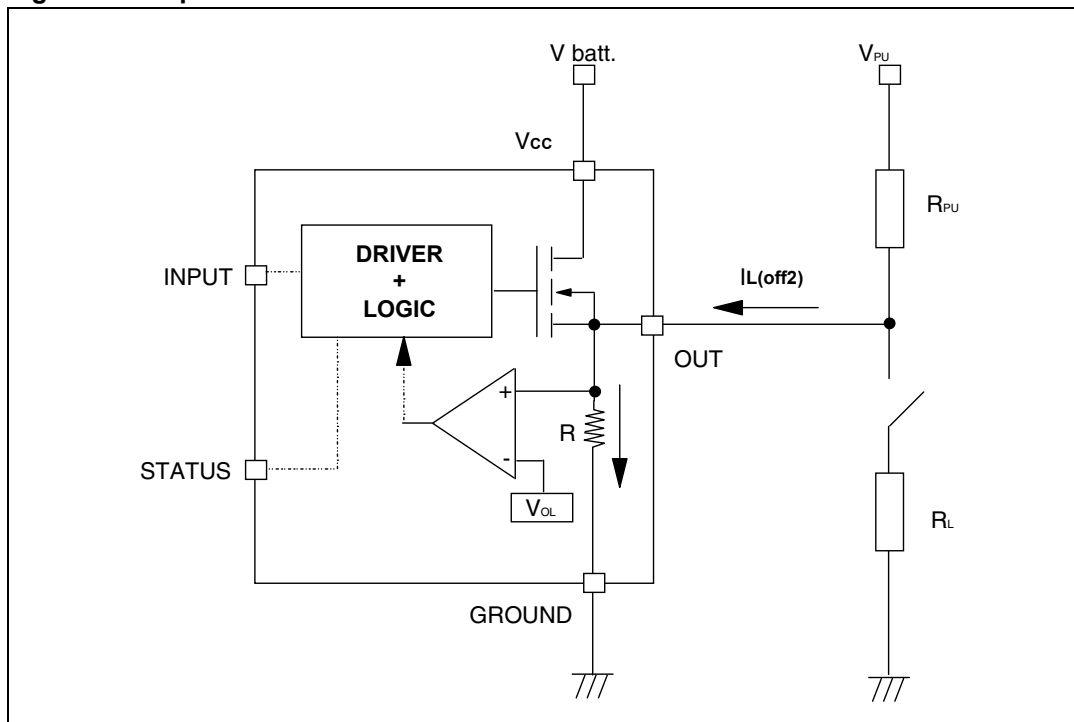

3.5 Maximum demagnetization energy ($V_{CC} = 13.5V$)

Figure 30. Maximum turn-off current versus inductance

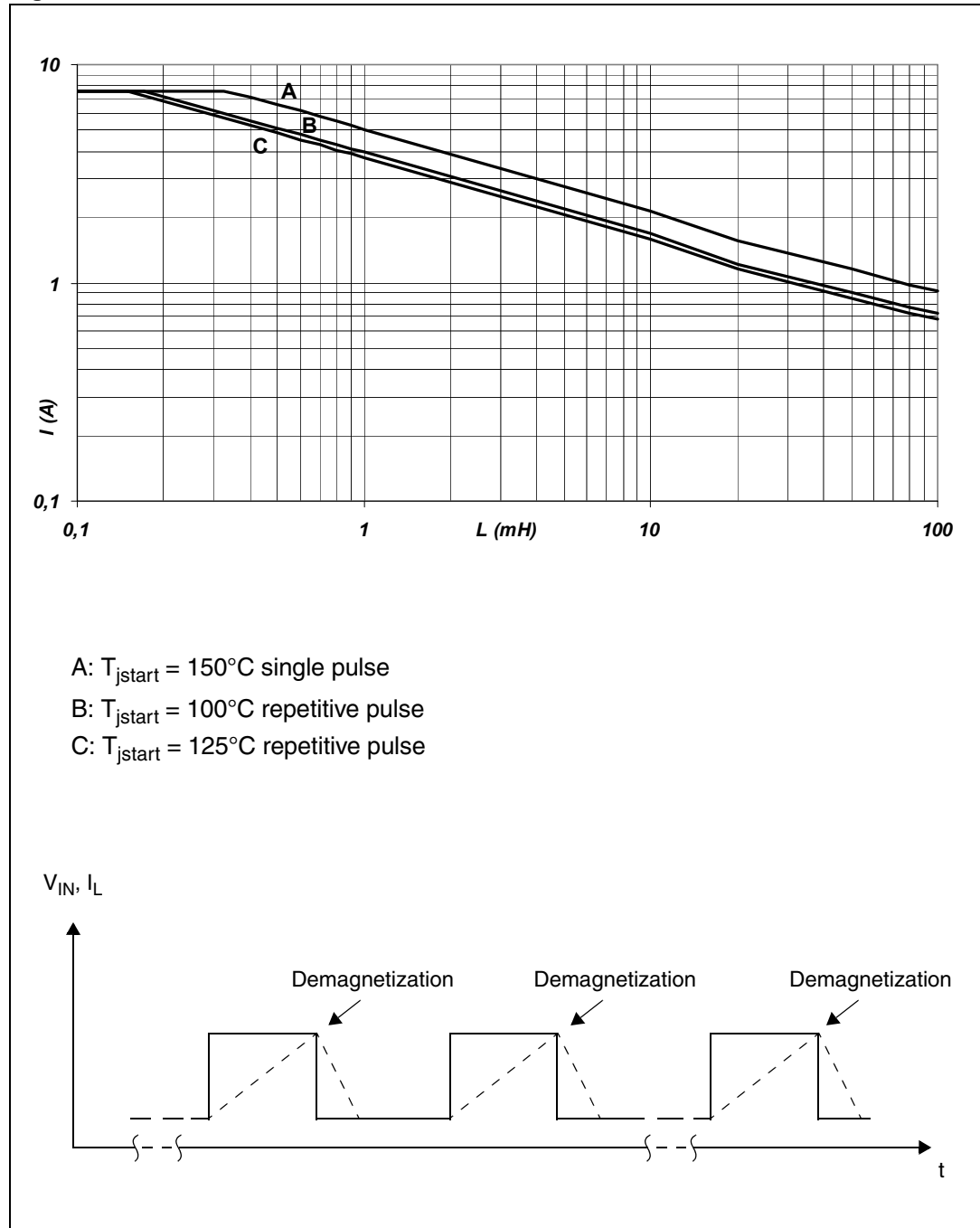

Note: Values are generated with $R_L = 0 \Omega$. In case of repetitive pulses, T_{jstart} (at beginning of each demagnetization) of every pulse must not exceed the temperature specified above for curves A and B.

4 Package and PCB thermal data

4.1 SO-8 thermal data

Figure 31. SO-8 PC board

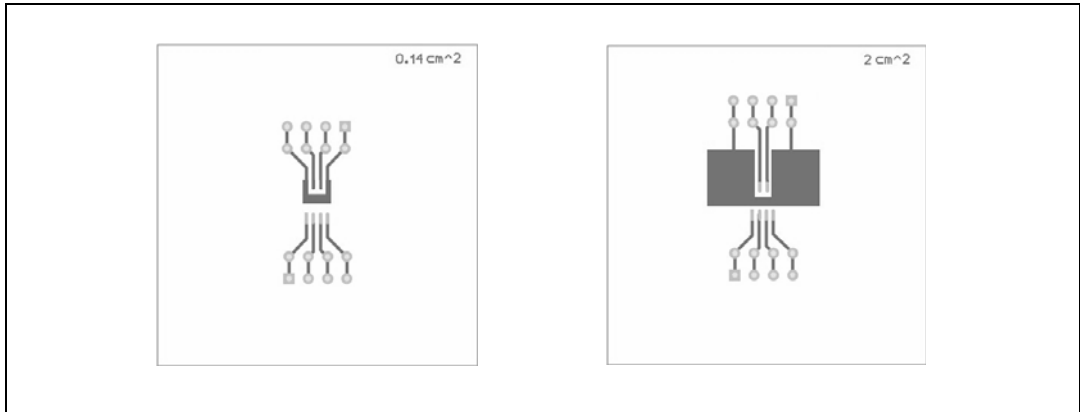

Note: Layout condition of R_{th} and Z_{th} measurements (PCB: FR4 area= 4.8 mm x 4.8 mm, PCB thickness=2 mm, Cu thickness= 35 μ m, Copper areas: from minimum pad lay-out to 2 cm²).

Figure 32. $R_{thj-amb}$ vs PCB copper area in open box free air condition

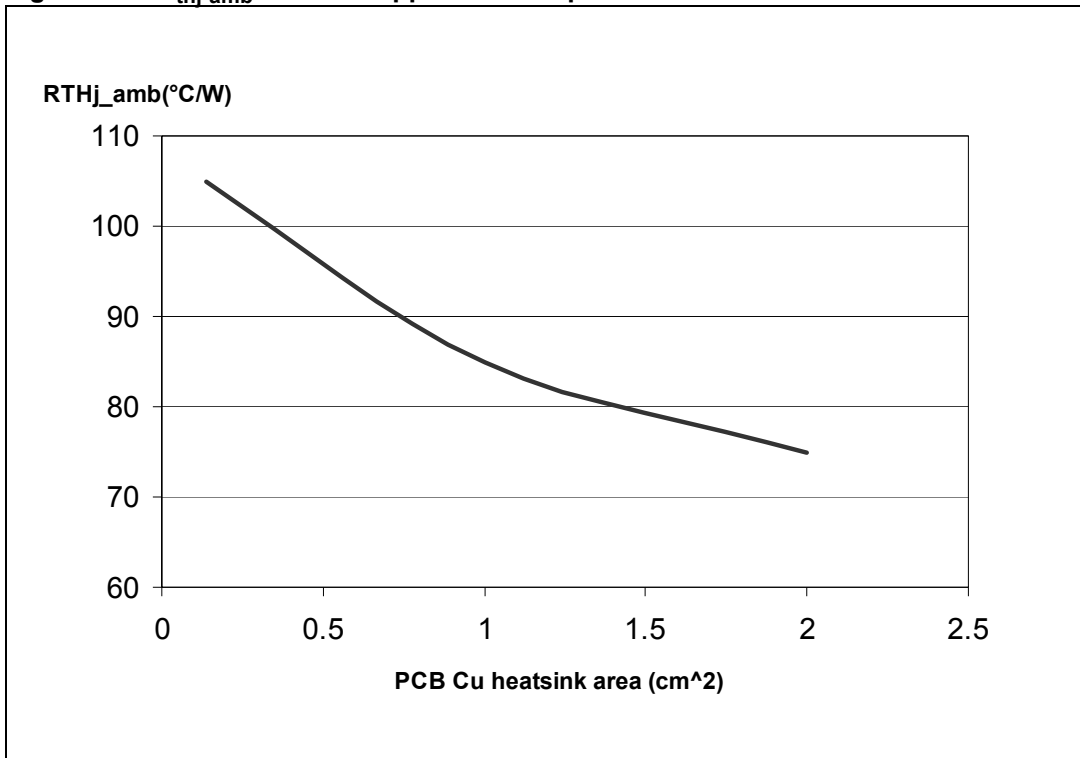
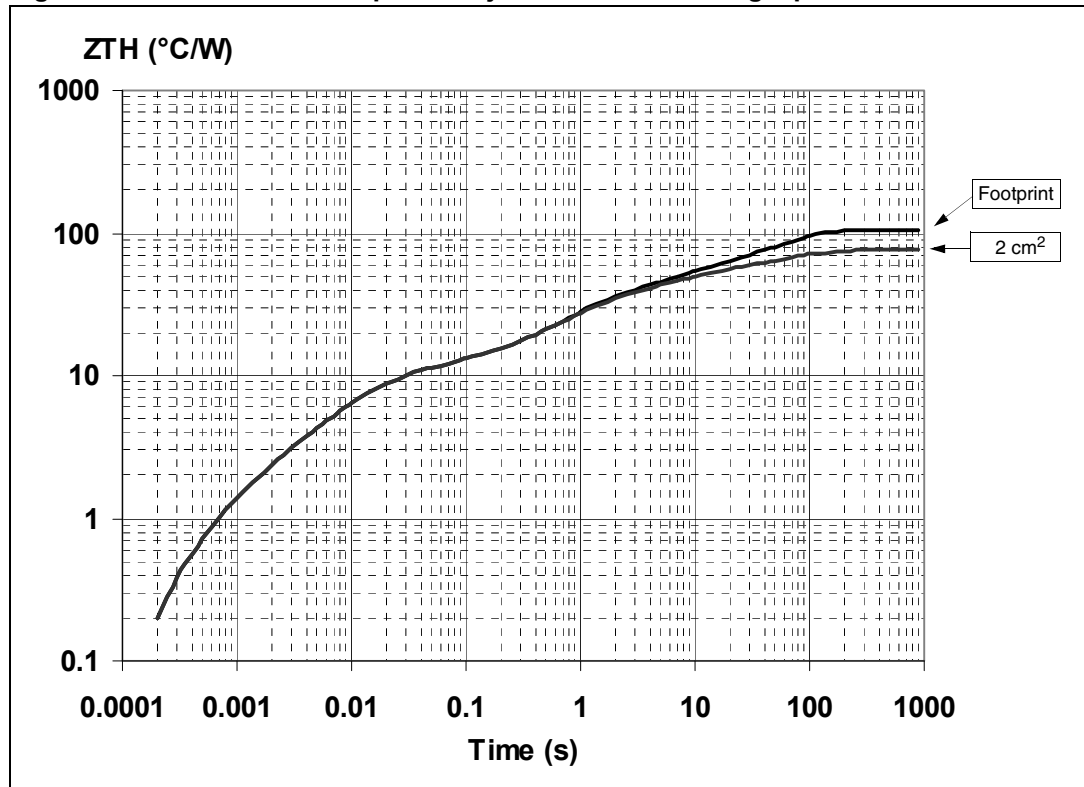

Figure 33. SO-8 Thermal impedance junction ambient single pulse



Equation 1: pulse calculation formula

$$Z_{TH\delta} = R_{TH} \cdot \delta + Z_{THtp}(1 - \delta)$$

where $\delta = t_p/T$

Figure 34. Thermal fitting model of a single-channel HSD in SO-8⁽¹⁾

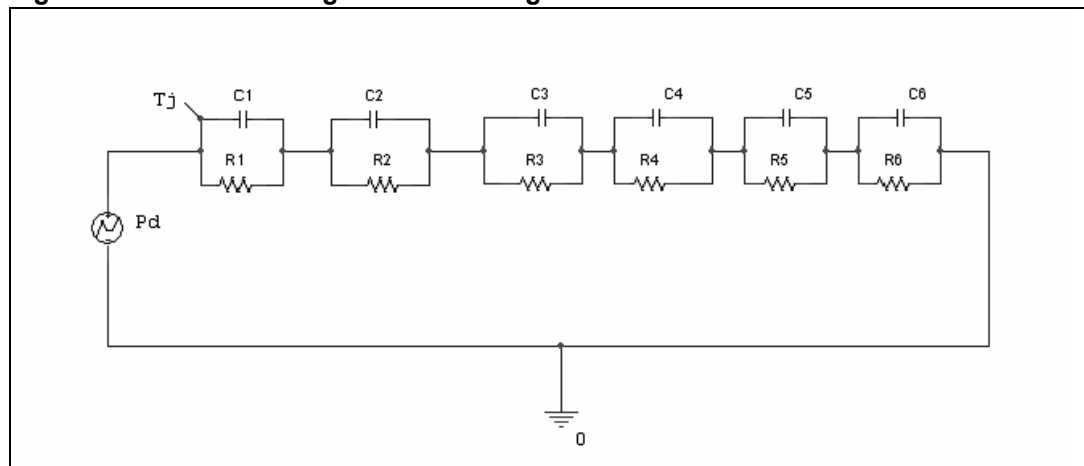

1. The fitting model is a simplified thermal tool and is valid for transient evolutions where the embedded protections (power limitation or thermal cycling during thermal shutdown) are not triggered.

Table 16. Thermal parameter

Area/island (cm ²)	Footprint	2
R1 (°C/W)	1.2	
R2 (°C/W)	6	
R3 (°C/W)	3.5	
R4 (°C/W)	21	
R5 (°C/W)	16	
R6 (°C/W)	58	28
C1 (W.s/°C)	0.0008	
C2 (W.s/°C)	0.0016	
C3 (W.s/°C)	0.0075	
C4 (W.s/°C)	0.045	
C5 (W.s/°C)	0.35	
C6 (W.s/°C)	1.05	2

5 Package and packing information

5.1 ECOPACK® packages

In order to meet environmental requirements, ST offers these devices in different grades of ECOPACK® packages, depending on their level of environmental compliance. ECOPACK® specifications, grade definitions and product status are available at: www.st.com.

ECOPACK® is an ST trademark.

5.2 Package mechanical data

Figure 35. SO-8 package dimensions

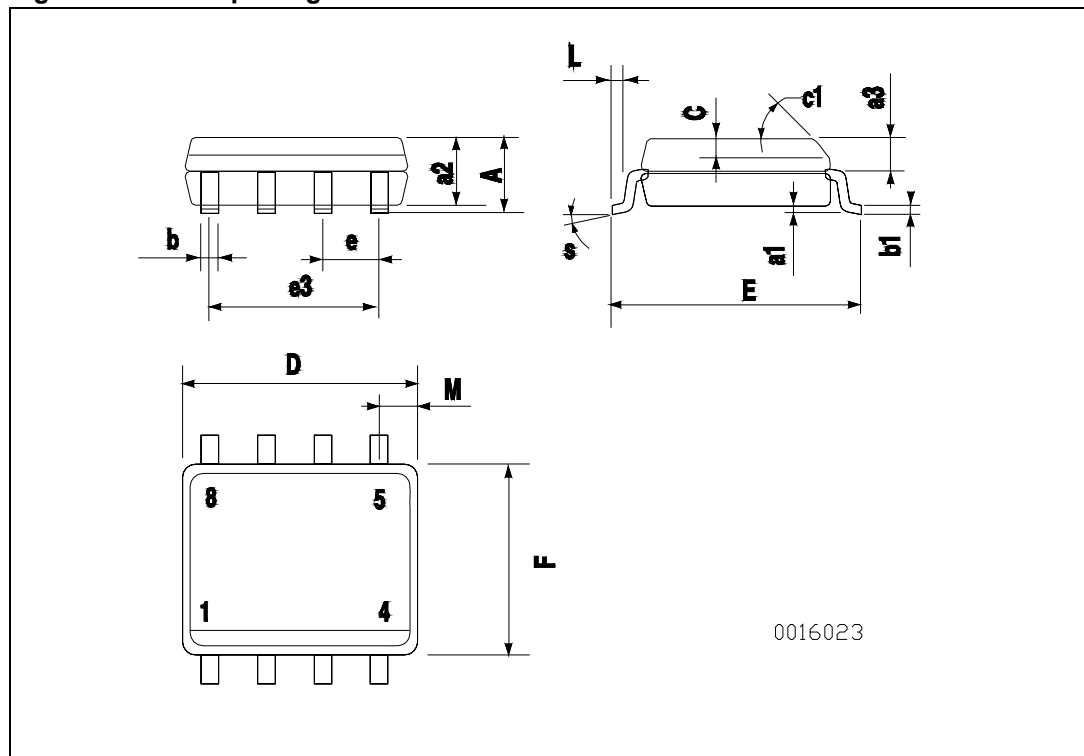

Table 17. SO-8 mechanical data

Dim.	Millimeter		
	Min.	Typ.	Max.
A			1.75
a1	0.1		0.25
a2			1.65
a3	0.65		0.85
b	0.35		0.48
b1	0.19		0.25
C	0.25		0.5
c1	45 (typ.)		
D	4.8		5
E	5.8		6.2
e		1.27	
e3		3.81	
F	3.8		4
L	0.4		1.27
M			0.6
S	8 (max.)		
L1	0.8		1.2

5.3 Packing information

Figure 36. SO-8 tube shipment (no suffix)

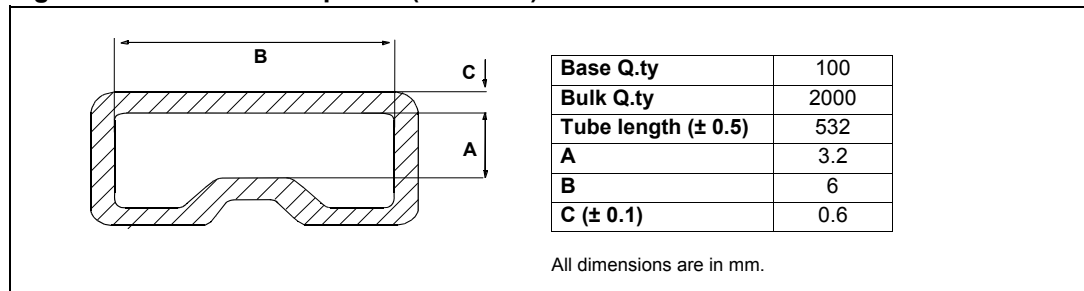
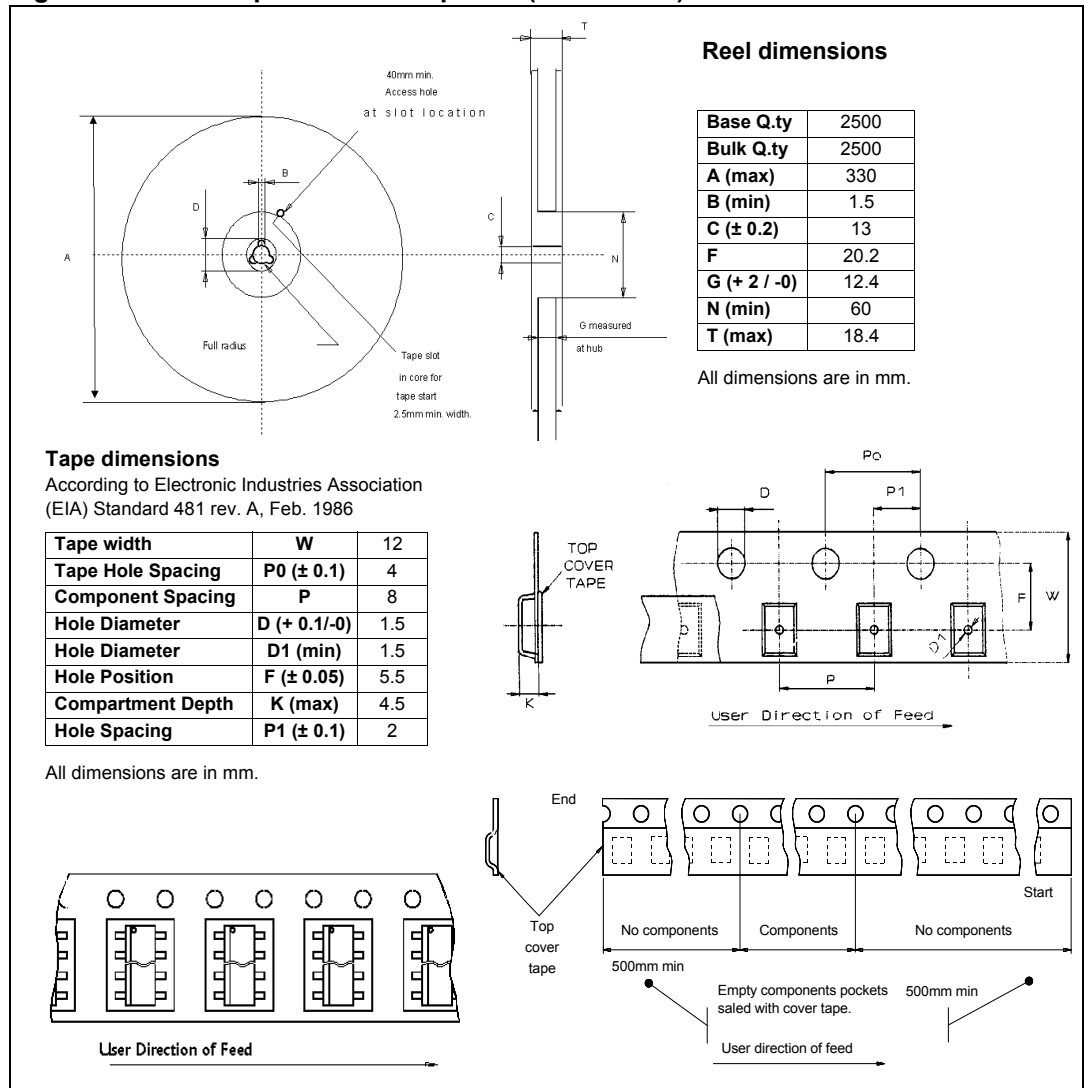

Figure 37. SO-8 tape and reel shipment (suffix “TR”)



6 Revision history

Table 18. Document revision history

Date	Revision	Changes
Feb-2007	1	Initial release.
May-2007	2	Document rewritten, restructured and put in corporate technical literature template.
17-Dec-2007	3	<p><i>Table 4: Absolute maximum ratings</i>: changed E_{MAX} value from 14 to 34 mJ.</p> <p><i>Table 13: Electrical transient requirements (part 1/3)</i>: updated test level values III and IV for test pulse 5b and notes.</p> <p>Added <i>Section 3.5: Maximum demagnetization energy (VCC = 13.5V)</i>.</p> <p><i>Figure 34: Thermal fitting model of a single-channel HSD in SO-8⁽¹⁾</i>: added note.</p>
23-Nov-2009	4	<p>Updated <i>Section 2.3: Electrical characteristics</i>.</p> <p>Updated <i>Section 2.4: Electrical characteristics curves</i>.</p> <p>Updated <i>Table 6: Power section</i>.</p>
20-Sep-2013	5	Updated Disclaimer

Please Read Carefully:

Information in this document is provided solely in connection with ST products. STMicroelectronics NV and its subsidiaries ("ST") reserve the right to make changes, corrections, modifications or improvements, to this document, and the products and services described herein at any time, without notice.

All ST products are sold pursuant to ST's terms and conditions of sale.

Purchasers are solely responsible for the choice, selection and use of the ST products and services described herein, and ST assumes no liability whatsoever relating to the choice, selection or use of the ST products and services described herein.

No license, express or implied, by estoppel or otherwise, to any intellectual property rights is granted under this document. If any part of this document refers to any third party products or services it shall not be deemed a license grant by ST for the use of such third party products or services, or any intellectual property contained therein or considered as a warranty covering the use in any manner whatsoever of such third party products or services or any intellectual property contained therein.

UNLESS OTHERWISE SET FORTH IN ST'S TERMS AND CONDITIONS OF SALE ST DISCLAIMS ANY EXPRESS OR IMPLIED WARRANTY WITH RESPECT TO THE USE AND/OR SALE OF ST PRODUCTS INCLUDING WITHOUT LIMITATION IMPLIED WARRANTIES OF MERCHANTABILITY, FITNESS FOR A PARTICULAR PURPOSE (AND THEIR EQUIVALENTS UNDER THE LAWS OF ANY JURISDICTION), OR INFRINGEMENT OF ANY PATENT, COPYRIGHT OR OTHER INTELLECTUAL PROPERTY RIGHT.

ST PRODUCTS ARE NOT DESIGNED OR AUTHORIZED FOR USE IN: (A) SAFETY CRITICAL APPLICATIONS SUCH AS LIFE SUPPORTING, ACTIVE IMPLANTED DEVICES OR SYSTEMS WITH PRODUCT FUNCTIONAL SAFETY REQUIREMENTS; (B) AERONAUTIC APPLICATIONS; (C) AUTOMOTIVE APPLICATIONS OR ENVIRONMENTS, AND/OR (D) AEROSPACE APPLICATIONS OR ENVIRONMENTS. WHERE ST PRODUCTS ARE NOT DESIGNED FOR SUCH USE, THE PURCHASER SHALL USE PRODUCTS AT PURCHASER'S SOLE RISK, EVEN IF ST HAS BEEN INFORMED IN WRITING OF SUCH USAGE, UNLESS A PRODUCT IS EXPRESSLY DESIGNATED BY ST AS BEING INTENDED FOR "AUTOMOTIVE, AUTOMOTIVE SAFETY OR MEDICAL" INDUSTRY DOMAINS ACCORDING TO ST PRODUCT DESIGN SPECIFICATIONS. PRODUCTS FORMALLY ESCC, QML OR JAN QUALIFIED ARE DEEMED SUITABLE FOR USE IN AEROSPACE BY THE CORRESPONDING GOVERNMENTAL AGENCY.

Resale of ST products with provisions different from the statements and/or technical features set forth in this document shall immediately void any warranty granted by ST for the ST product or service described herein and shall not create or extend in any manner whatsoever, any liability of ST.

ST and the ST logo are trademarks or registered trademarks of ST in various countries.

Information in this document supersedes and replaces all information previously supplied.

The ST logo is a registered trademark of STMicroelectronics. All other names are the property of their respective owners.

© 2013 STMicroelectronics - All rights reserved

STMicroelectronics group of companies

Australia - Belgium - Brazil - Canada - China - Czech Republic - Finland - France - Germany - Hong Kong - India - Israel - Italy - Japan - Malaysia - Malta - Morocco - Philippines - Singapore - Spain - Sweden - Switzerland - United Kingdom - United States of America

www.st.com